

OS柵

PA.PEN
Quality is all.
Oike

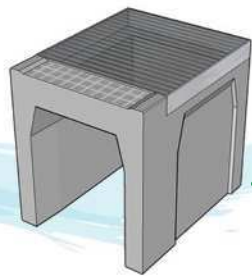

OS MASU

街をスッキリ・美しく

◆OS側溝と同じ外幅ですので、外側(民地側)・内側(道路側)にはみでることがありません。

従来の柵

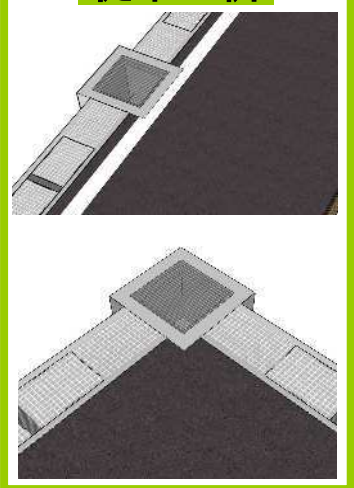

OS柵

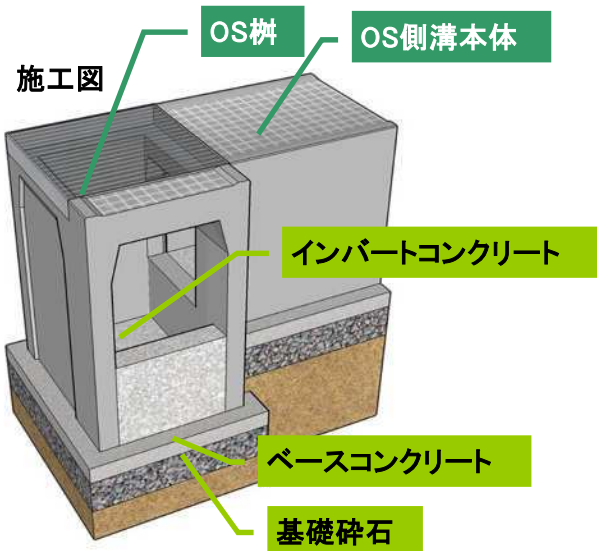
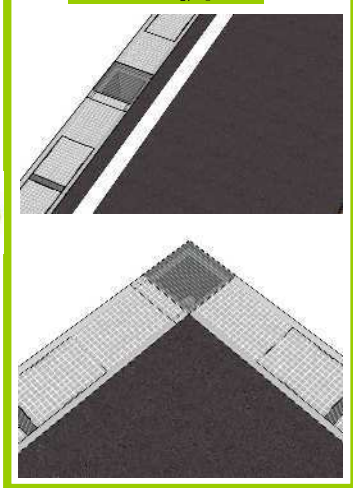

◆鉄筋を入れてあるので、ロックアウト(3面)を使用できます。

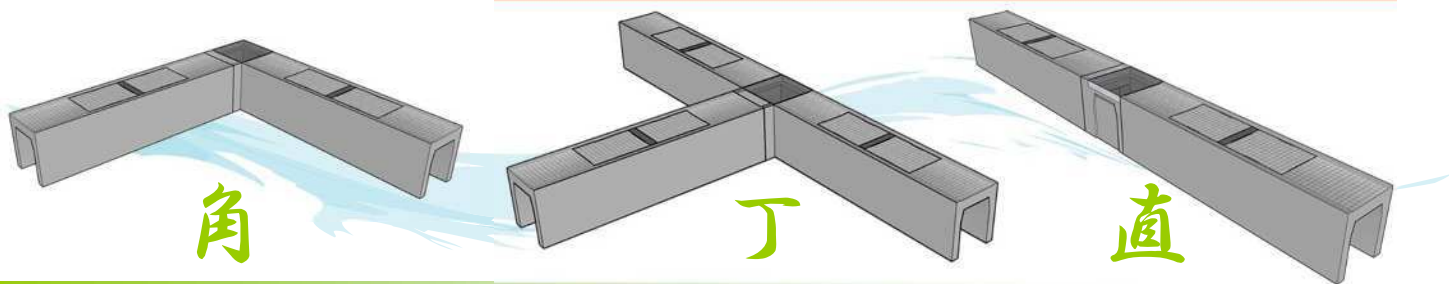

施工写真



OS可変側溝用 OS樹 構造図 S=1/20

※ C面は開口済みです。

【平面図】

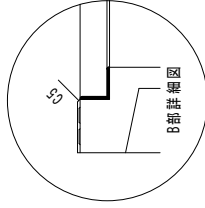
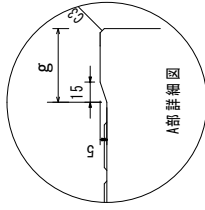
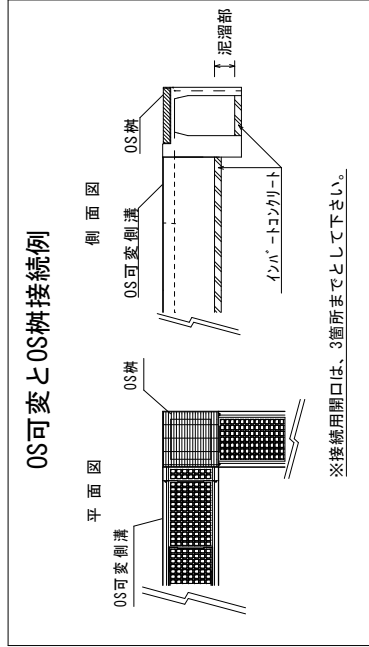
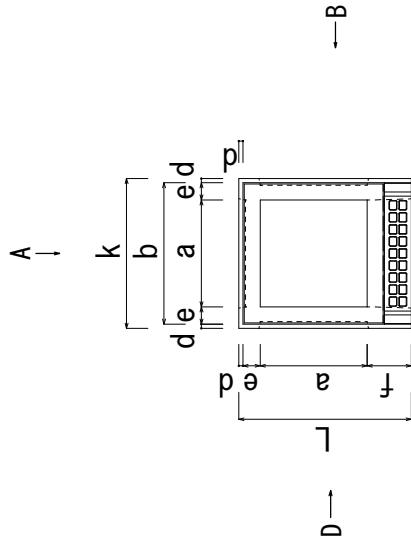

OS樹規格寸法表

呼び名	OS対応サイズ	a	b	d	e	f	k	L	g	h	H	参考重量 (kg)	
300	300*300									500	590	103	
	400*300									600	690	118	
	500*300									700	790	133	
	600*300									800	890	148	
	700*300									900	990	163	
400	800*300	300	420		60	160			45	1000	1090	178	
	900*300									1085	1190	212	
	1000*300									1185	1290	227	
	1100*300									1285	1390	241	
	1200*300									1385	1490	256	
500	400*400									600	705	166	
	500*400									700	805	186	
	600*400									800	905	207	
	700*400									900	1005	228	
	800*400									1000	1105	249	
600	900*400	400	530		65	165			50	1085	1205	308	
	1000*400									1185	1305	330	
	1100*400									1285	1405	351	
	1200*400									1385	1505	373	
	1300*400									1485	1605	395	
700	500*500									600	720	175	
	600*500									700	820	187	
	700*500									800	920	199	
	800*500									900	1020	211	
	900*500									1000	1120	223	
800	1000*500	500	650		75	175			55	1100	1220	235	
	1100*500									1200	1320	247	
	1200*500									1300	1420	259	
	1300*500									1400	1520	271	
	1400*500									1500	1620	283	
900	600*600									700	835	241	
	700*600									800	935	254	
	800*600									900	1035	267	
	900*600									1000	1135	280	
	1000*600									1100	1235	293	
1000	1100*600	600	760		80	180			55	1200	1335	306	
	1200*600												
	1300*600												
	1400*600												
	1500*600												

【C面側面図】

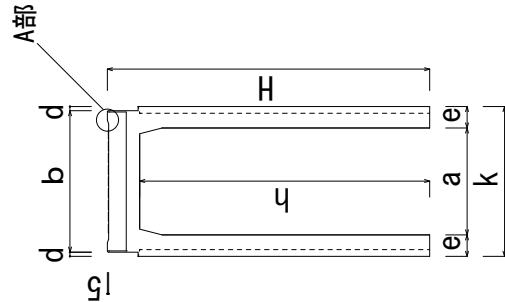

【B面側面図】

